

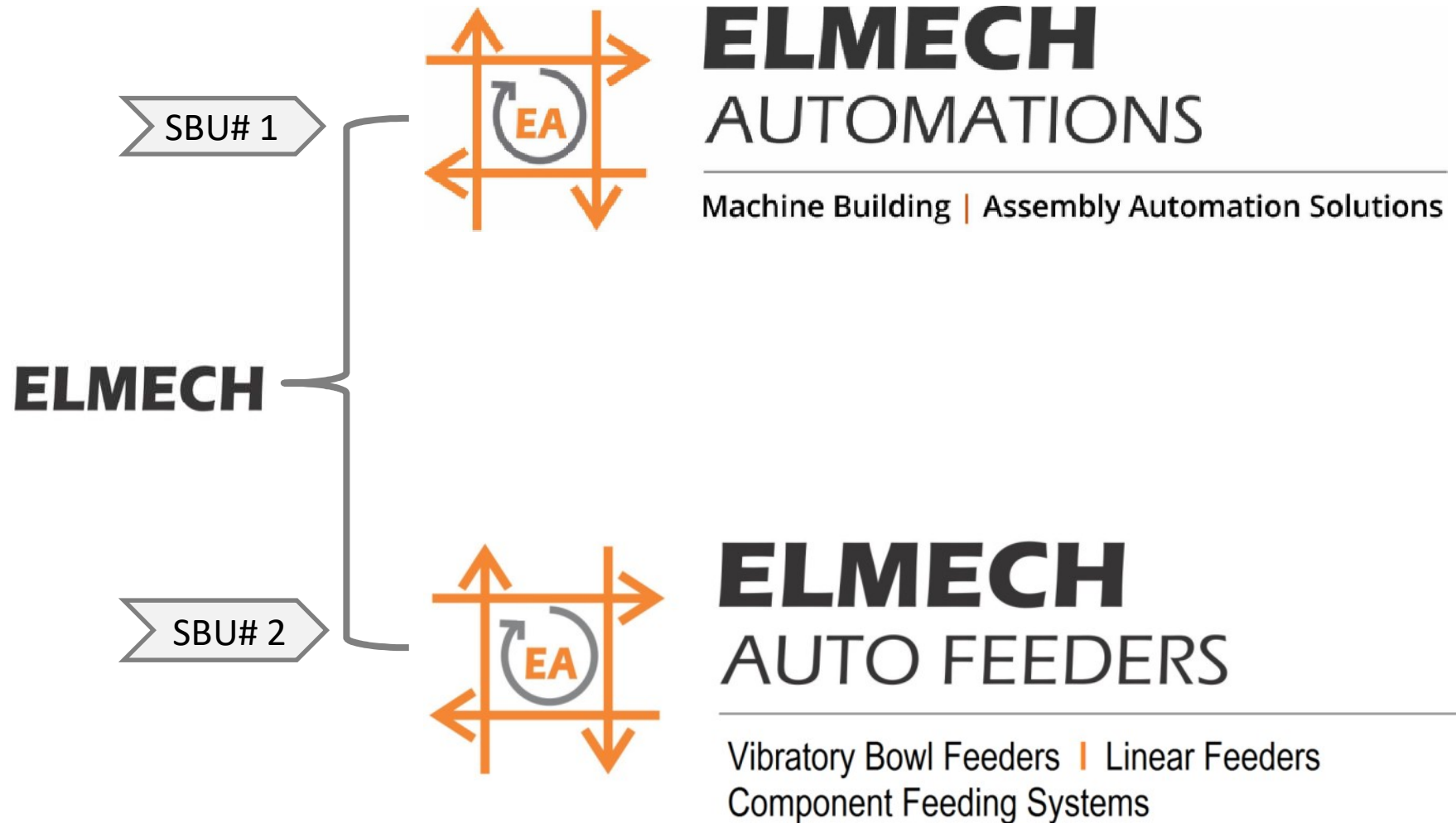

WELCOME

.....



EVOLUTION OF ELMECH....



Registration of the company



ELMECH
AUTOMATIONS
Machine Building | Assembly Automation Solutions

SPM's for Rubber Industry – High Volumes

Delivered Standard Product (Shoe Scrubber)

Participated in Rubber Expo 2007

Dedicated Functions formed / Design expertise resources added

Rotary Assembly lines, Vision Inspection systems, Automation with bowl feeders
Participated in Intec exhibition 2013

Last 5yrs business

2016-17 : 4.6 Cr
2017-18 : 6.9 Cr
2018-19 : 7.5 Cr
2019-20 : 7.2 Cr
2020-21 : 4.4 Cr

2021-22

Order in Hand – 10 Cr
Closed on 3rd qtr – 06 Cr

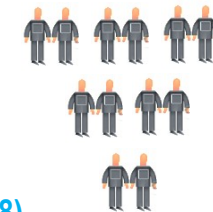

(52)

2014-16
2017-18

(48)

Rev: 2.11 Cr

2012-13

(29)

Rev : 0.81 Cr

2009-11

(22)

Rev : 0.60 Cr

2008

(18)

Rev : 0.45 Cr

2007

(11)

Rev : 0.4 Cr

2006

(5)

2010
Started Bowl feeders Mfg Indigenously

Assembly Automation / Testing systems / Gained expertise in PLC / PC, Hydraulic, Servo based SPM's

- 2006 > Established
- 2015 > Moved to own space for office and plant – 10000 Sqft
- 2015 > 10000 Sqft available for future expansion
- 2016 > Bowl Feeders individual revenues recognized
- 2016 > Stepped into International market
- 2021 > Stepped into European market

ORGANISATION STRUCTURE

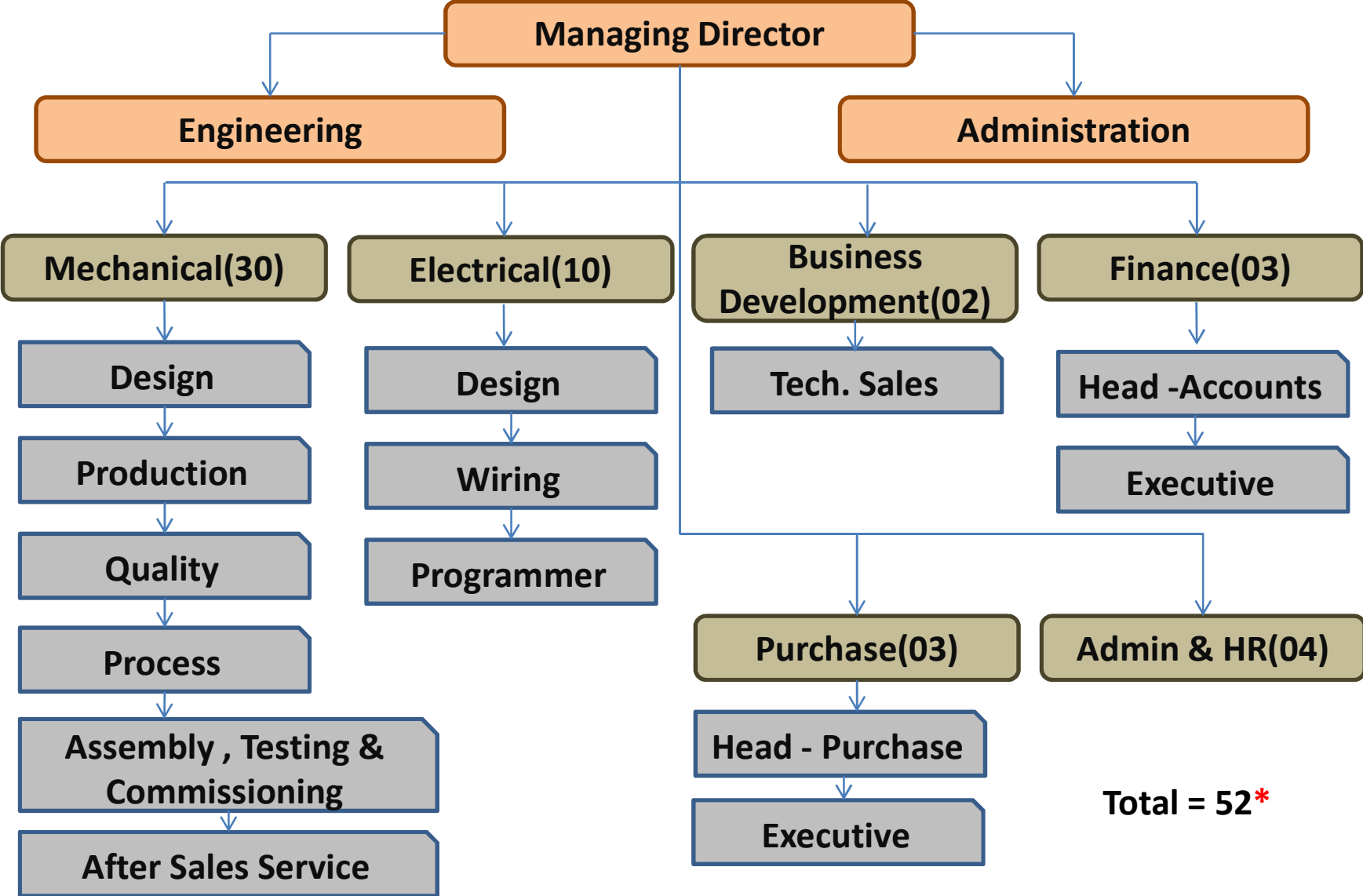

INFRASTRUCTURE



All Under One Roof.....



DESIGN CENTRE



INFRASTRUCTURE

All Under One Roof.....



SHOP FLOOR



QA & QC

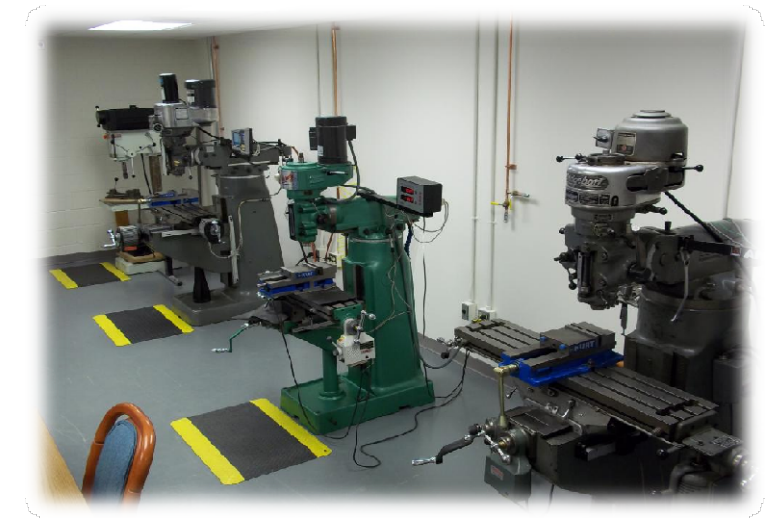

IN-HOUSE MACHINE SHOP



STORES & PURCHASE

DESIGN TOOLS/SOFTWARE

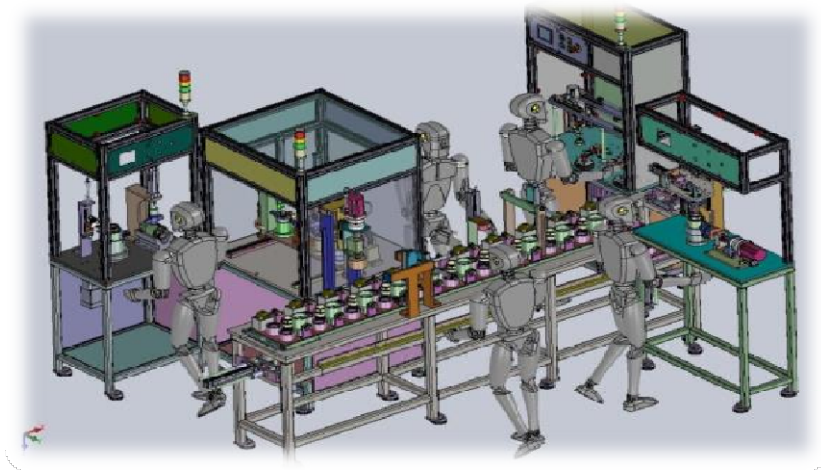

Task Name	Duration	Start	Finish	Priority	Resources
Office Move	70 days	Mon 1/14/10	Thu 4/29/10		
Two To Six Months Before Moving	18 days	Mon 1/14/10	Wed 2/24/10		\$100K
Day					
Make list of key needs that must be met by new office space	7 days	Mon 1/14/10	Tue 1/12/10	High	
Identify potential office sites	30 days	Wed 1/11/10	Tue 2/9/10	Medium	
Prepare a budget for the move	30 days	Wed 2/10/10	Tue 2/23/10	High	
Select the move day	1 day	Wed 2/24/10	Wed 2/24/10	High	
Communicate to employees	1 day	Wed 2/24/10	Wed 2/24/10	Medium	
Phase one closeout	0 days	Wed 2/24/10	Wed 2/24/10		
One To Two Months Before Moving Day	13 days	Thu 2/25/10	Mon 3/15/10		
Assign office space	5 days	Thu 2/25/10	Fri 3/5/10	Low	
Move movers	1 day	Mon 3/8/10	Mon 3/8/10	Medium	
Evaluate computing and server room needs	2 days	Tue 3/9/10	Wed 3/10/10		
Order phone and internet lines	1 day	Thu 3/11/10	Thu 3/11/10		
Arrange for cleaning service	1 day	Fri 3/12/10	Fri 3/12/10		
Review for re-opening	1 day	Mon 3/22/10	Mon 3/22/10		



TCS - ERP system.....
 For Procurement, stores and project cost management and material movement

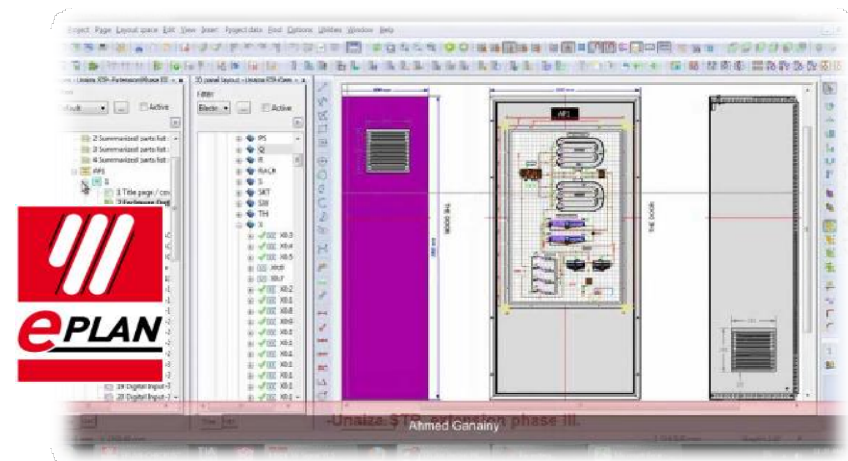

OUR COMPETENCY



**SPECIAL PURPOSE
MACHINES**

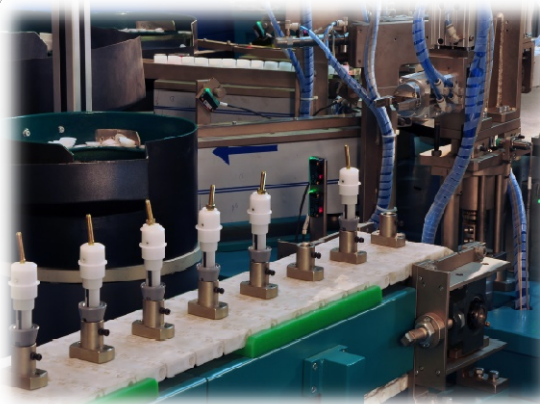

**LINEAR TRANSFER
ASSEMBLY LINES**

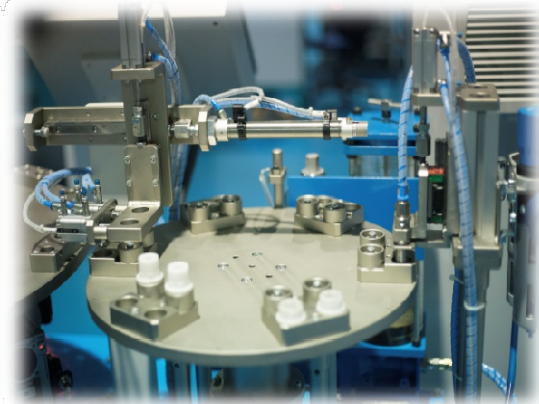

**ROTARY ASSEMBLY
LINES**



CONVEYORS

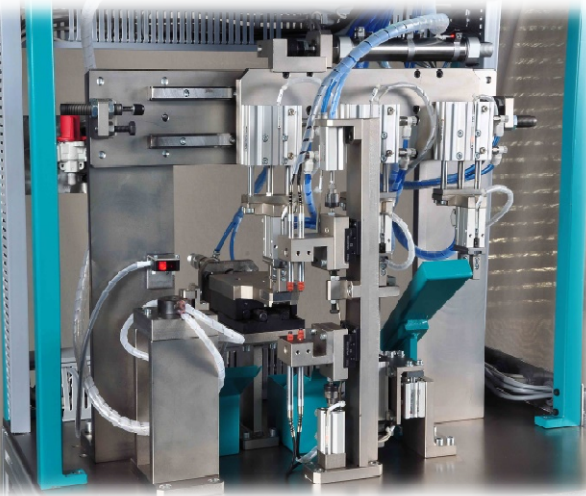

**ASSEMBLY AND PROCESS
EQUIPMENT**



**VISION INSPECTION
SYSTEMS**



**SERVO CONTROLLED
SPECIAL PURPOSE
MACHINES**



LEAN ASSEMBLY CELLS

Strong Hands on experiences



PROCESS

- Assembly
- Screwing
- Riveting & Forming
- Pressing
- Adhesive Application
- O ring Assembly
- Greasing
- Threading
- Packaging
- Pick n Places – Servo
- Pick n Places – Pneumatic
- Part feeding & Handling systems

CONTROLS, TESTING & INSPECTION

- Servo & Scada systems
- PC based Data storage system
- PLC with Industry 4.0 Standards
- LVDT measurement
- Force measurement
- Pressure, Flow & Leak testing
- Electrical Parameters
- Labeling
- Vision Inspection
- Sorting
- Counting

Our Bowl feeding systems....



- Bowls
- Drive Units
- Control Boxes
- Accessories



where reliability
is built in for life



TYPE OF BOWLS WE make...

**CYLINDRICAL BOWLS
MODEL – CYBO**



**STEP BOWLS
MODEL – STBO**



**CONICAL BOWLS
MODEL – COBO**



COATING FOR BOWLS

Urethane

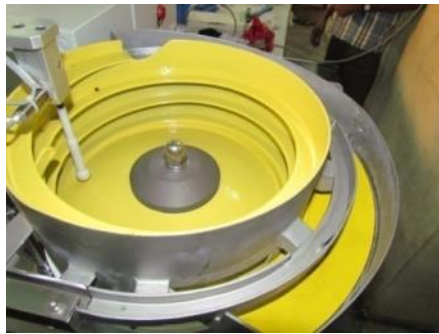

UHMWPE



3M Brushlon



ACCESSORIES

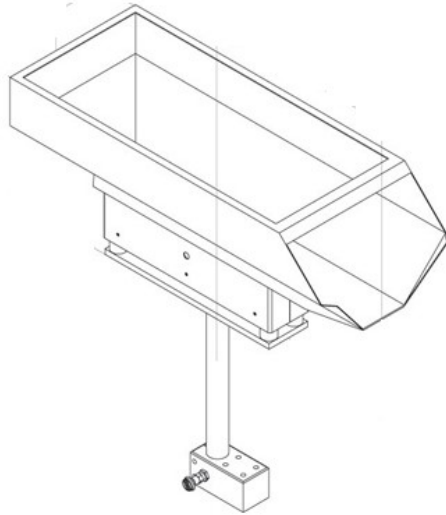

Vibratory Hopper

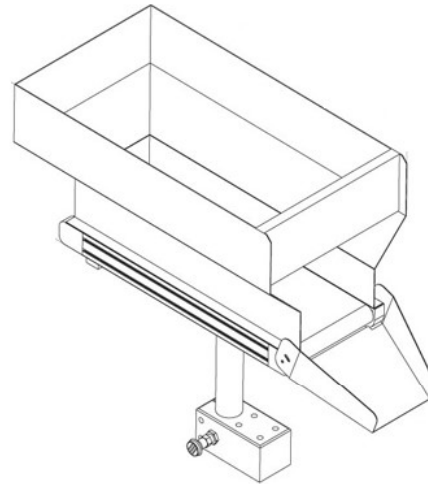

Conveyor Hopper



Elevated Hopper

- **Low level sensor for Bowls**
- **Track level sensor for Linear feeders**
- **Base Plate with stand**

BOWLS WE MAKE....

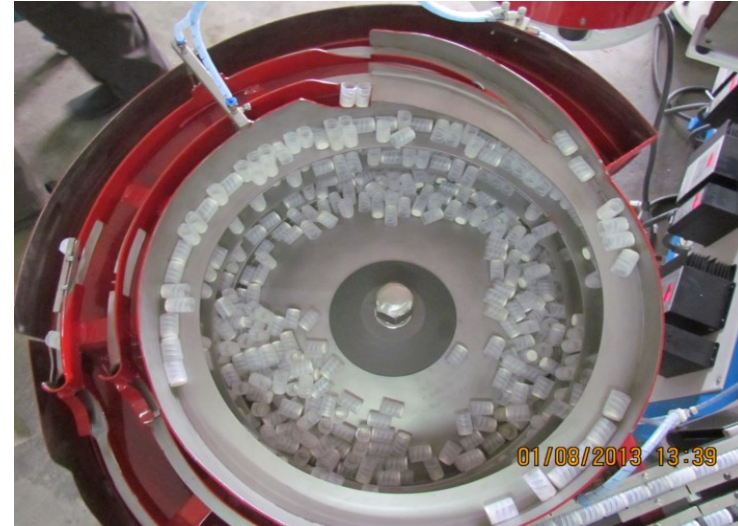
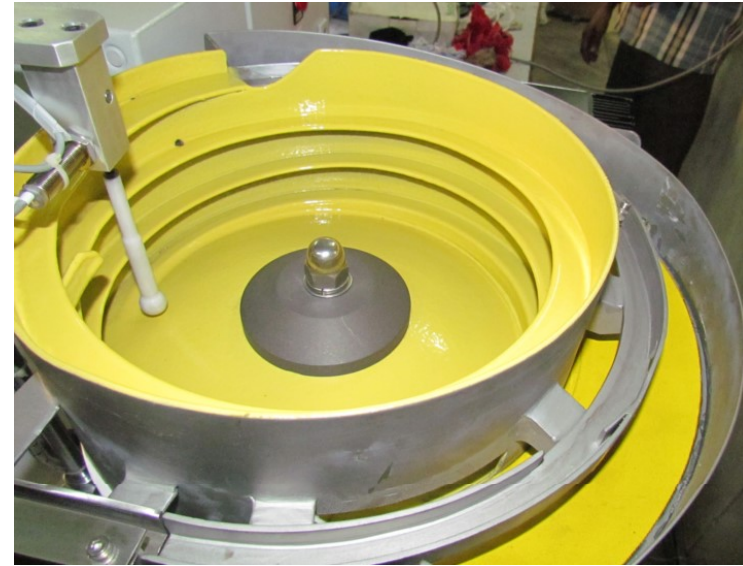
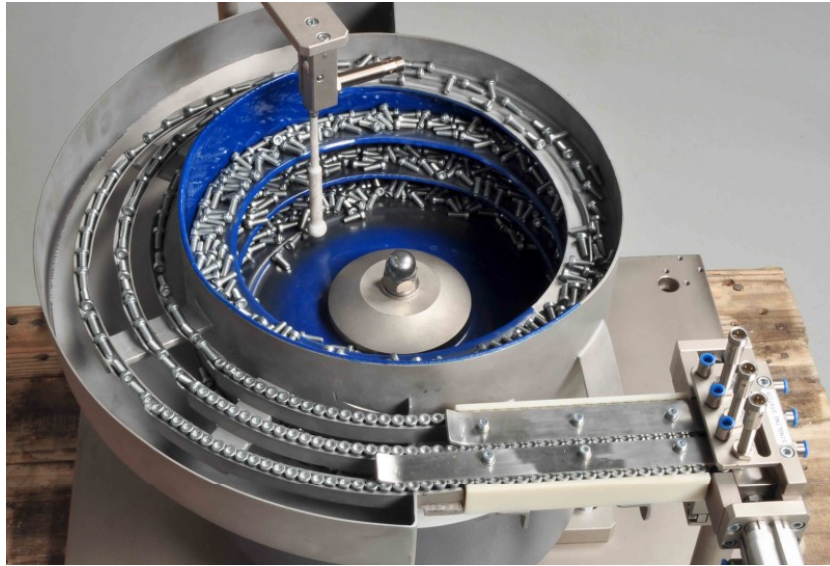

BOWLS WE MADE....

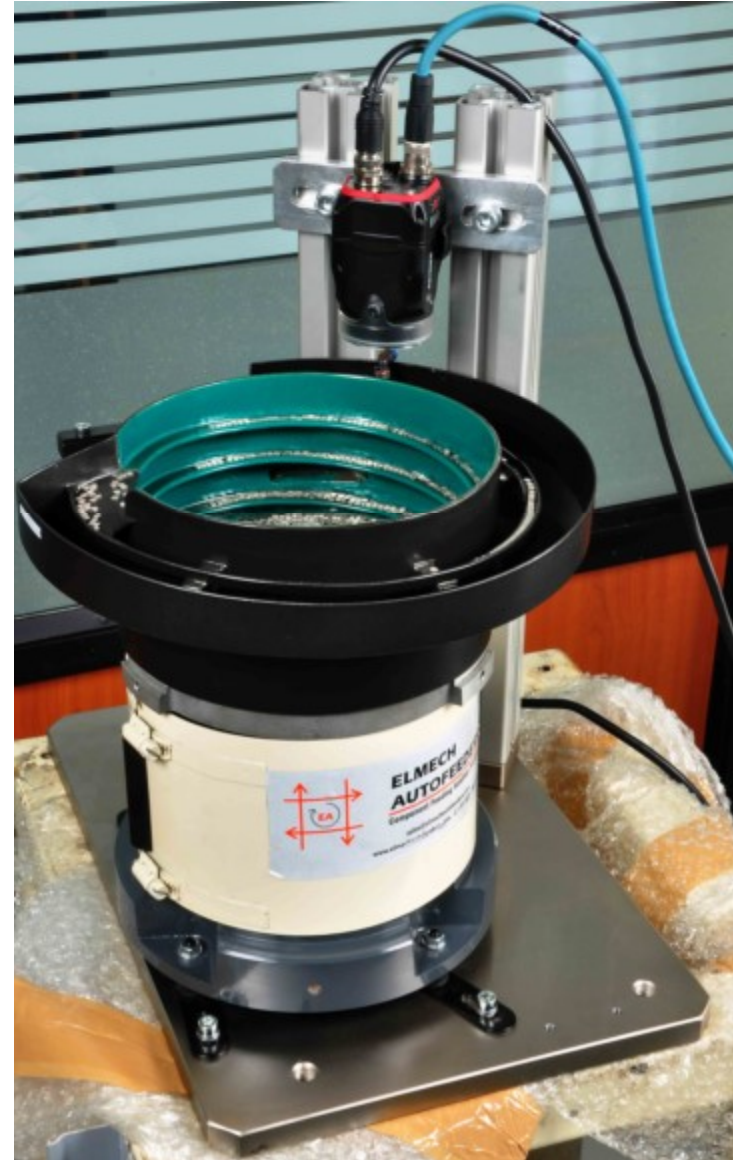
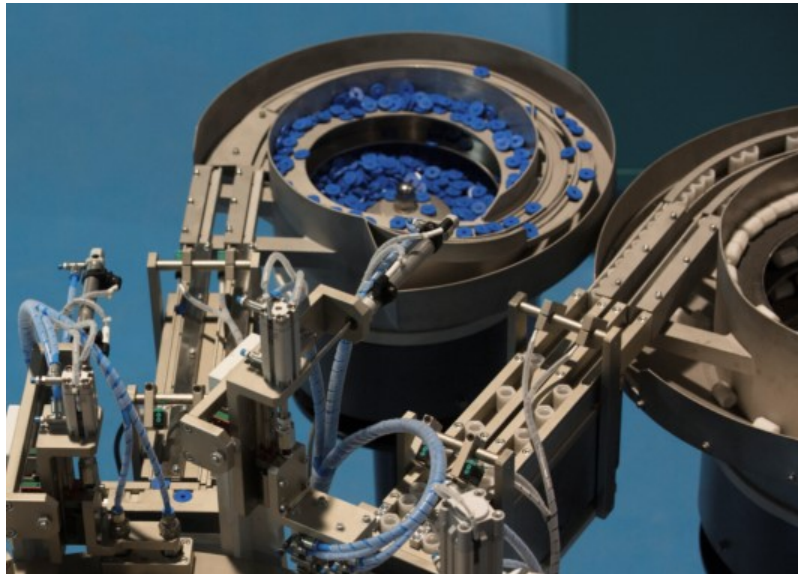
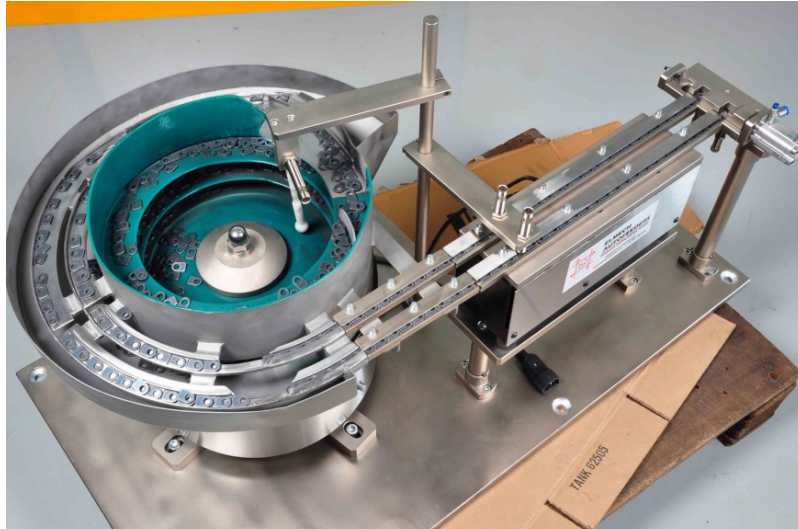

BOWLS WE MADE....

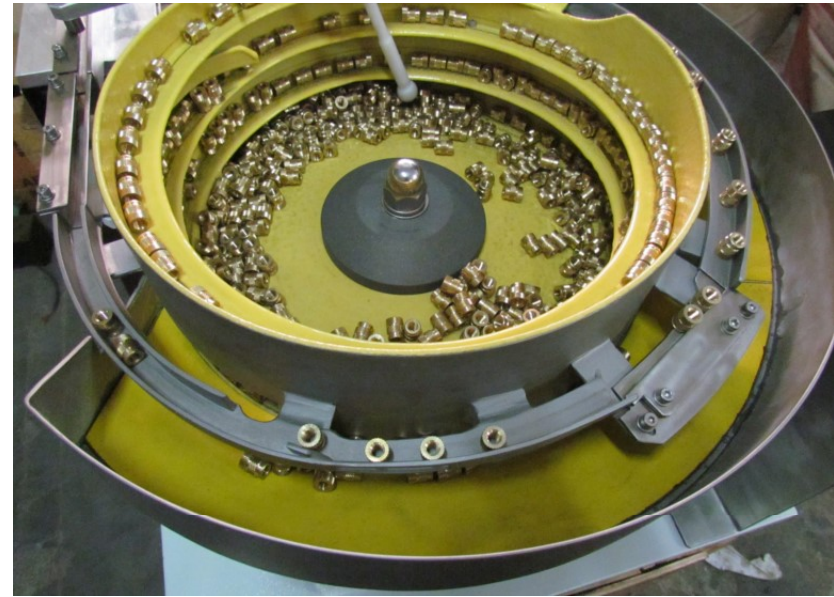

BOWLS WE MADE....

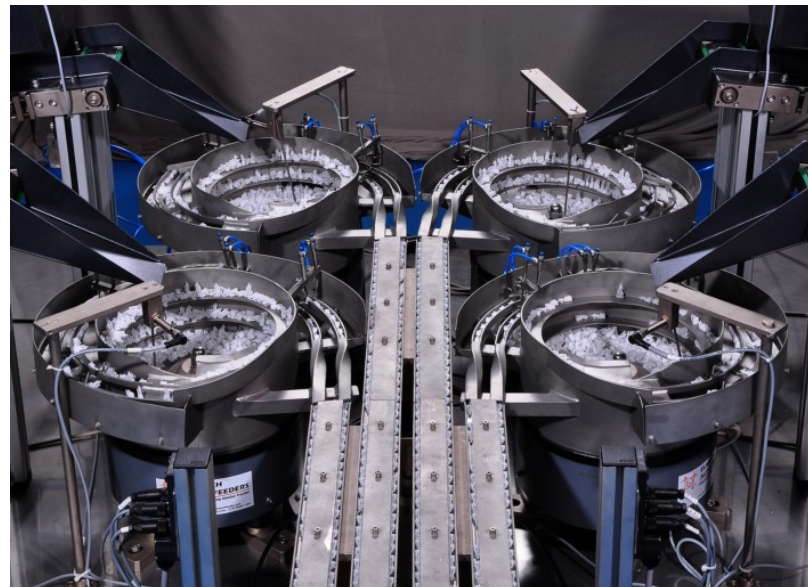
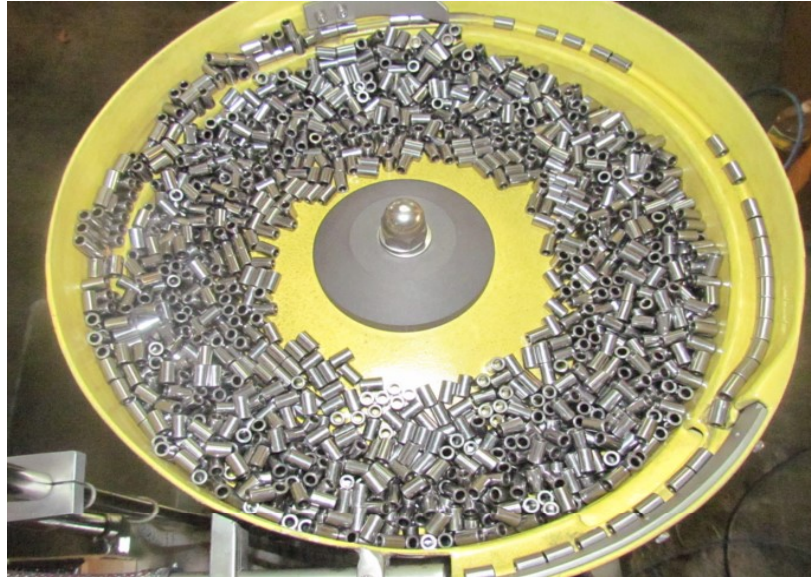

OUR BOWL FEEDER RUN IN Sectors like

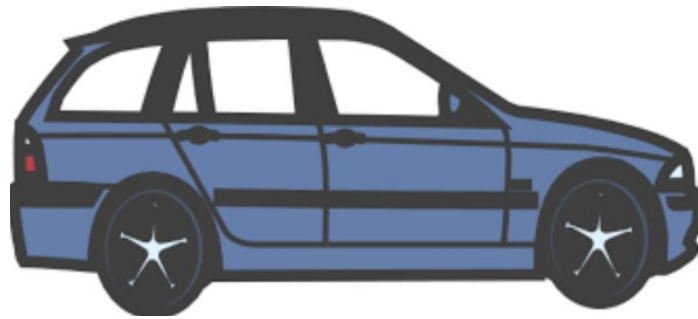

AUTOMOTIVE



ELECTRICAL



2-WHEELER



ELECTRONICS

OUR BOWL FEEDER RUN IN Sectors like



TAPS / FAUCETS



FASTENERS



BEARINGS



TOYS

OUR BOWL FEEDER RUN IN Sectors like



PHARMA



MEDICAL DEVICES



TEXTILE



O-RINGS

In Mfg of BOWL Feeding Systems *We maintain...*



- Very high quality / finish / aesthetics
- Durable coating
- On-time delivery
- Library of production
- Quality assurance & delivery with pre-dispatch check-list & Equipment Manual
- Right pricing depend upon the criticality and work involved.
- Good infrastructure and manufacturing standards
- Quick prototypes to conclude orientation / feed rate

CUSTOMERS LIST



CUSTOMERS LIST



Thank **you** for **your** attention.....

For enquiries and to know more
about ELMECH



<https://www.linkedin.com/in/vishnu-prakash-jayachandran-140315192/>

.....END.....

Head Office & Factory :

No 28-N1, South Garden street,
Sengalipalayam, Edikarai,
Coimbatore – 22

Tamil Nadu , INDIA.

Mobile : +91 944312341

e-mail : vishnu@elmechapl.com

Sales@elmechapl.com